

LM100, LM300 Voltage Regulator

FEATURES

- Output voltage adjustable from 2V to 30V
- One percent load and line regulation
- One percent stability over full military temperature range
- Adjustable short circuit current limiting
- Output currents in excess of 5A possible by adding external transistors
- Can be used as either a linear or high-efficiency switching regulator

GENERAL DESCRIPTION

The Intersil 100/300 monolithic integrated circuit is a voltage regulator. It is designed for use in applications that range from digital power supplies to precision regulators.

The output voltage is adjustable from 2V to 30V with a 1% load and line regulation. Short circuit current limiting is also adjustable. By adding external transistors, output currents in excess of 5A are possible.

The device can be used as either a linear or high-efficiency switching regulator, and will start on any load within rating. It responds quickly to both load and line transients and features small standby power dissipation, and freedom from oscillations with varying resistive and reactive loads.

SCHEMATIC DIAGRAM

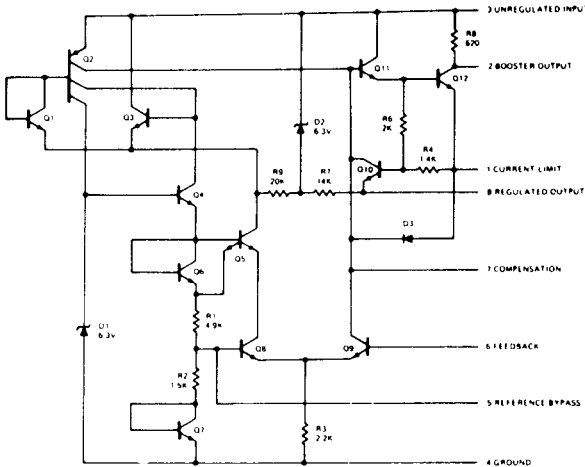

PIN CONFIGURATIONS

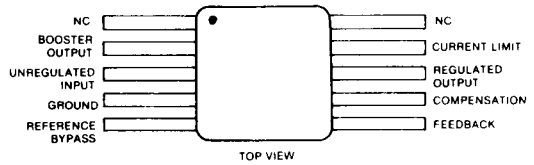

(outline dwg FB)

NOTE: Pin 4 connected to bottom of package.

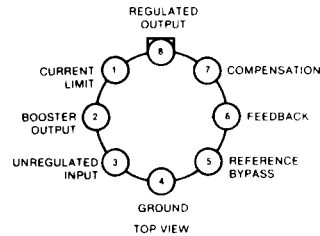

(outline dwg TY)

NOTE: Pin 4 connected to case.

5

ORDERING INFORMATION

Part number	To 99 Can	10-Pin Flatpak	Dice
LM100	LM100H*	LM100F	LM100/D
LM300	LM300H	—	LM300/D

* Add /883B to order if 883B processing is desired.

ABSOLUTE MAXIMUM RATINGS

	LM100	LM300
Input Voltage	40V	35V
Input-Output Voltage Differential	40V	30V
Power Dissipation (Note 1)	500 mW	300 mW
Operating Junction Temperature Range	-55°C to +150°C	0°C to 70°C
Storage Temperature Range	-65°C to +150°C	-55°C to 125°C
Lead Temperature (Soldering, 60 sec)	300°C	260°C

ELECTRICAL CHARACTERISTICS (Note 2)

5

PARAMETER	CONDITIONS	LM100			LM300			UNITS
		MIN	TYP	MAX	MIN	TYP	MAX	
Input Voltage Range		8.5		40	8.0		30	V
Output Voltage Range		2.0		30	2.0		20	V
Output-Input Voltage Differential		3.0		30	3.0		20	V
Load Regulation (Note 3)	$R_{SC} = 0, I_O < 12 \text{ mA}$		0.1	0.5		0.1	0.5	%
Line Regulation	$V_{IN} - V_{OUT} \leq 5V$		0.1	0.2		0.1	0.2	%/V
	$V_{IN} - V_{OUT} > 5V$		0.05	0.1		0.05	0.1	%/V
Temperature Stability	$-55^\circ\text{C} \leq T_A \leq +125^\circ\text{C}$		0.3	1.0				%
	$0^\circ\text{C} \leq T_A \leq 70^\circ\text{C}$					0.3	2.0	%
Feedback Sense Voltage			1.8			1.8		V
Output Noise Voltage	$10 \text{ Hz} \leq f \leq 10 \text{ kHz}$							
	$C_{REF} = 0$		0.005			0.005		%
	$C_{REF} = 0.1 \mu\text{F}$		0.002			0.002		%
Long Term Stability			0.1	1.0		0.1	1.0	%
Standby Current Drain	$V_{IN} = 40V$		1.0	3.0				mA
	$V_{IN} = 30V$					1.0	3.0	mA
Minimum Load Current	$V_{IN} - V_{OUT} = 30V$		1.5	3.0				mA
	$V_{IN} - V_{OUT} = 20V$					1.5	3.0	mA

NOTE 1: The maximum junction temperature of the 100 is 150 C, while that of the 300 is 100 C. For operating at elevated temperatures devices in the TO-5 package must be derated based on a thermal resistance of 150 C/W, junction to ambient or 45 C/W, junction to case. For the flat package, the derating is based on thermal resistance of 185 C/W when mounted on a 1/16-inch-thick epoxy glass board with ten 0.03-inch-wide, 2-ounce copper conductors. Peak dissipations to 1W are allowable providing the dissipation rating is not exceeded with the power averaged over a five second interval.

NOTE 2: These specifications apply for a junction temperature between -55°C and +150°C, (100) 0°C and 70°C, (300) for input and output voltages within the ranges given, and for a divider impedance seen by the feedback terminal of 2 kΩ, unless otherwise specified. The load and line regulation specifications are for constant junction temperature. Temperature drift effects must be taken into account separately when the unit is operating under conditions of high dissipation.

NOTE 3: The output currents given, as well as the load regulation, can be increased by the addition of external transistors. The improvement factor will be roughly equal to the composite current gain of the added transistors.

TYPICAL PERFORMANCE CHARACTERISTICS FOR 100, 300*

REGULATION CHARACTERISTICS WITHOUT CURRENT LIMITING

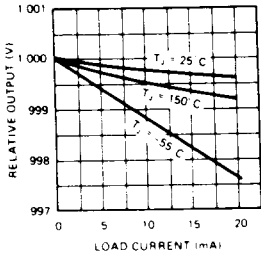

REGULATION CHARACTERISTICS WITH CURRENT LIMITING

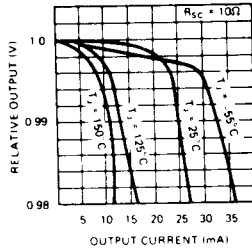

CURRENT LIMITING CHARACTERISTICS

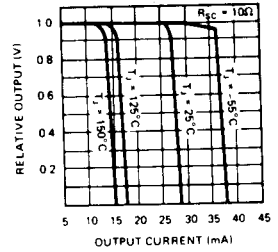

CURRENT LIMIT SENSE VOLTAGE AS A FUNCTION OF JUNCTION TEMPERATURE

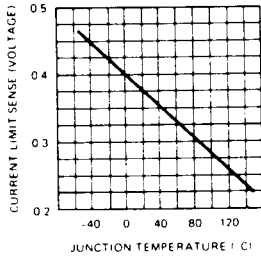

SHORT CIRCUIT CURRENT AS A FUNCTION OF JUNCTION TEMPERATURE

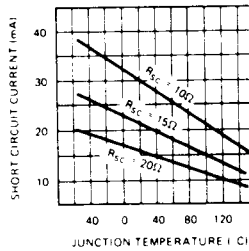

OPTIMUM DIVIDER RESISTANCE VALUES AS A FUNCTION OF OUTPUT VOLTAGE

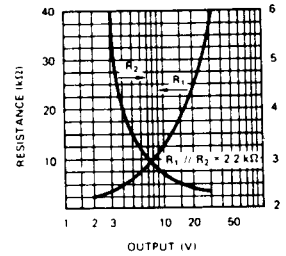

5

MINIMUM INPUT VOLTAGE AS A FUNCTION OF JUNCTION TEMPERATURE

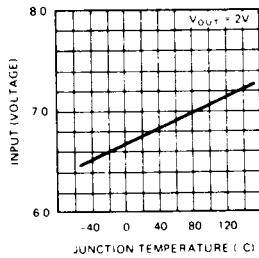

REGULATOR DROPOUT VOLTAGE AS A FUNCTION OF JUNCTION TEMPERATURE

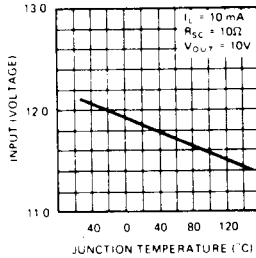

SUPPLY VOLTAGE REJECTION AS A FUNCTION OF INPUT OUTPUT VOLTAGE DIFFERENTIAL

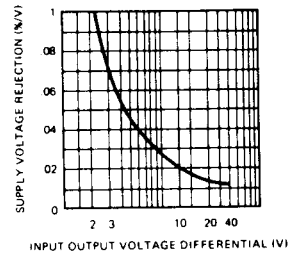

MINIMUM LOAD CURRENT AS A FUNCTION OF INPUT OUTPUT VOLTAGE DIFFERENTIAL

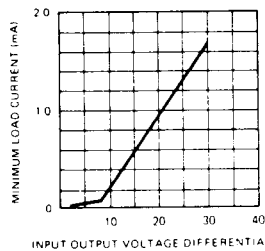

LOAD TRANSIENT RESPONSE

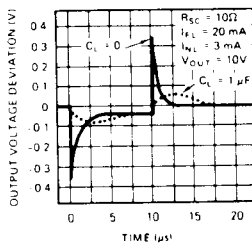

LINE TRANSIENT RESPONSE

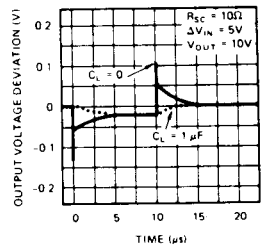

* 300 Only Guaranteed $0^{\circ}\text{C} < T_A < 70^{\circ}\text{C}$

DEFINITION OF TERMS

INPUT VOLTAGE RANGE: The range of DC input voltages over which the regulator will operate within specifications.

OUTPUT VOLTAGE RANGE: The range of regulated output voltages over which the specifications apply.

OUTPUT-INPUT VOLTAGE DIFFERENTIAL: The voltage difference between the unregulated input voltage and the regulated output voltage for which the regulator will operate within specifications.

LINE REGULATION: The percentage change in regulated output voltage for a change in input voltage.

LOAD REGULATION: The percentage change in regulated output voltage for a change in load from the minimum load to the maximum load current specified.

CURRENT-LIMIT SENSE VOLTAGE: The voltage across the current limit terminals required to cause the regulator to current-limit with a short circuited output. This voltage is used to determine the value of the external current-limit resistor when external booster transistors are used.

TEMPERATURE STABILITY: The percentage change in output voltage for a thermal variation from room temperature to either temperature extreme.

FEEDBACK SENSE VOLTAGE: The voltage, referred to ground, on the feedback terminal of the regulator while it is operating in regulation.

OUTPUT NOISE VOLTAGE: The average AC voltage at the output with constant load and no input ripple.

STANDBY CURRENT DRAIN: That part of the operating current of the regulator which does not contribute to the load current.

TYPICAL APPLICATIONS

5

Basic Regulator Circuit

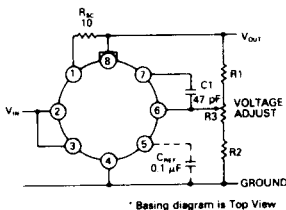

200 mA Regulator

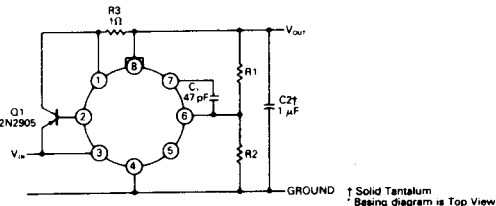

2A Regulator With Foldback Current Limiting

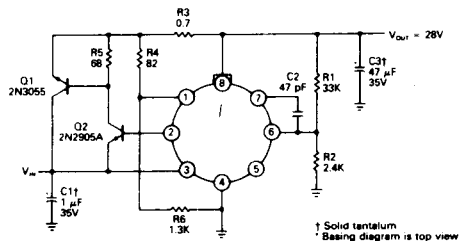

4A Switching Regulator

